

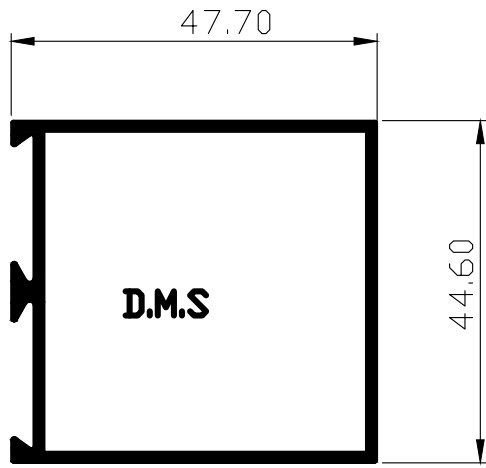



# PARAGON ALUMINIUM L.L.P



SECTION. NO	WT.Kgs/15' ft
14000	2.800 TO 3.100
14001	3.800 TO 4.100
14002	4.800 TO 5.100
14003	6.800 TO 7.100

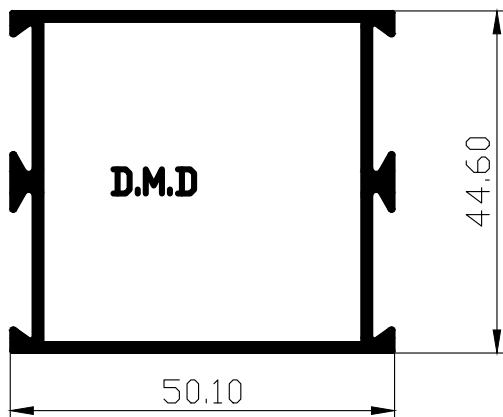

SECTION. NO	WT.Kgs/15' ft
14006	2.800 TO 3.100
14007	3.800 TO 4.100
14008	4.800 TO 5.100
14009	6.800 TO 7.100

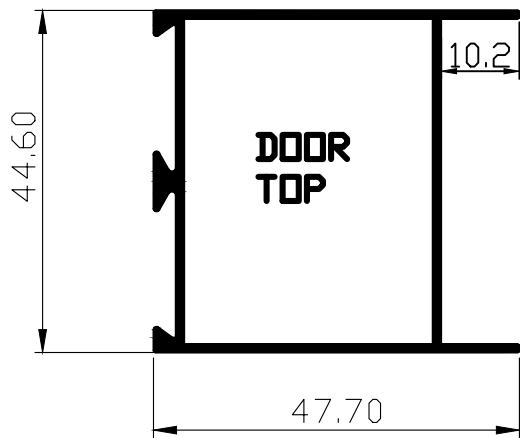

SECTION. NO	WT.Kgs/15' ft
14011	2.800 TO 3.100
14012	3.800 TO 4.100
14013	4.800 TO 5.100
14014	6.800 TO 7.100

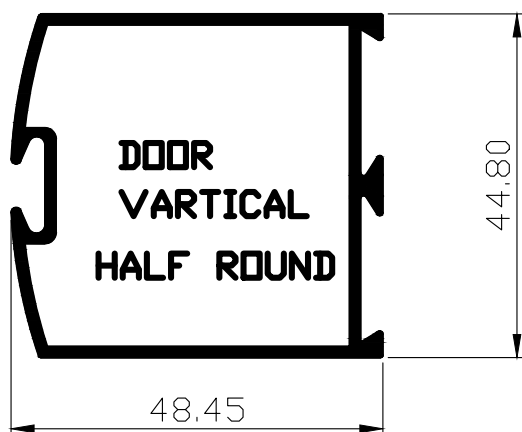

SECTION. NO	WT.Kgs/15' ft
14016	2.800 TO 3.100
14017	3.800 TO 4.100
14018	4.800 TO 5.100
14019	6.800 TO 7.100

# PARAGON ALUMINIUM L.L.P

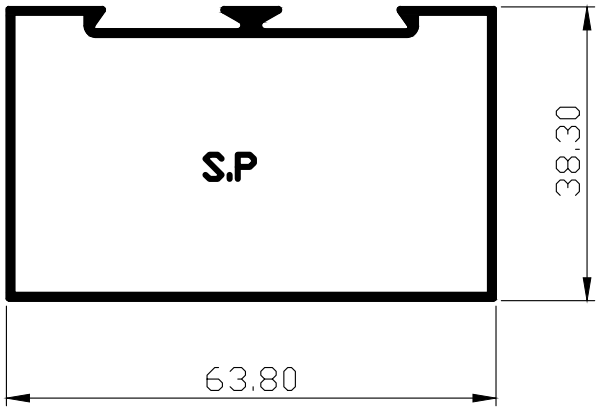

SECTION. NO	WT.Kgs/15' ft
14020	2.800 TO 3.100
14021	3.500 TO 3.800
14022	3.800 TO 4.100
14023	4.800 TO 5.100
14024	6.800 TO 7.100

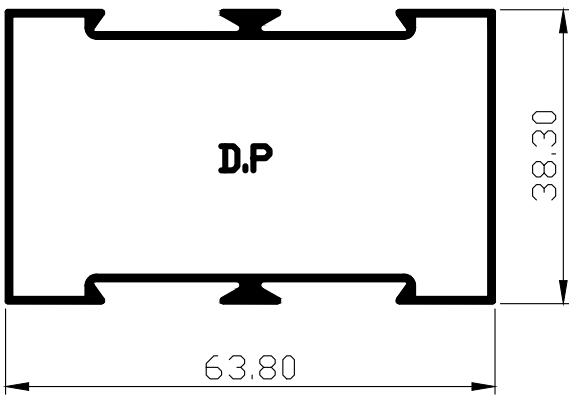

SECTION. NO	WT.Kgs/15' ft
14026	2.800 TO 3.100
14027	3.500 TO 3.800
14028	3.800 TO 4.100
14029	4.800 TO 5.100
14030	6.800 TO 7.100

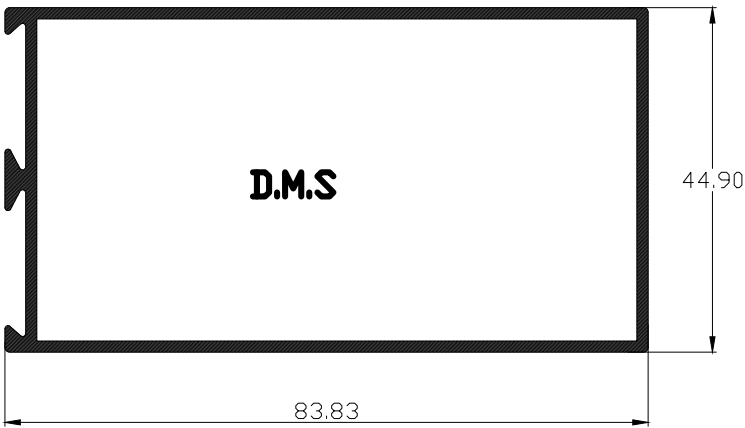

SECTION. NO	WT.Kgs/15' ft
14031	4.800 TO 5.100
14032	6.800 TO 7.100
14033	8.800 TO 9.100

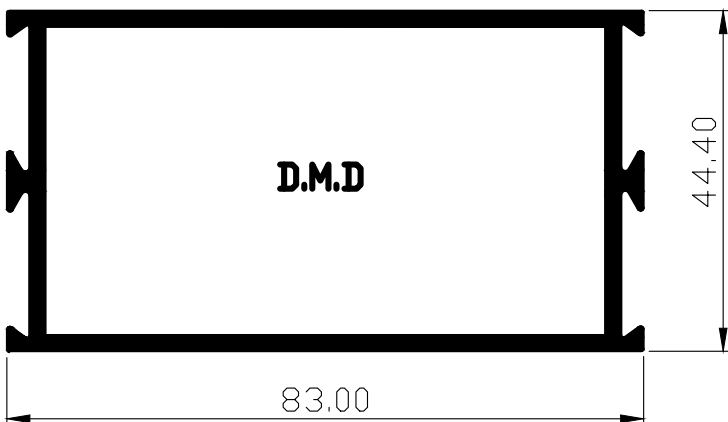

SECTION. NO	WT.Kgs/15' ft
14035	4.800 TO 5.100
14036	6.800 TO 7.100
14037	8.800 TO 9.100

# PARAGON ALUMINIUM L.L.P



SECTION. NO	WT.Kgs/15' ft
14039	4.800 TO 5.100
14040	6.800 TO 7.100
14041	8.800 TO 9.100



SECTION. NO	WT.Kgs/15' ft
14047	4.800 TO 5.100
14048	6.800 TO 7.100
14049	8.800 TO 9.100



SECTION. NO	WT.Kgs/15' ft
14054	4.800 TO 5.100
14056	6.800 TO 7.100
14057	8.800 TO 9.100

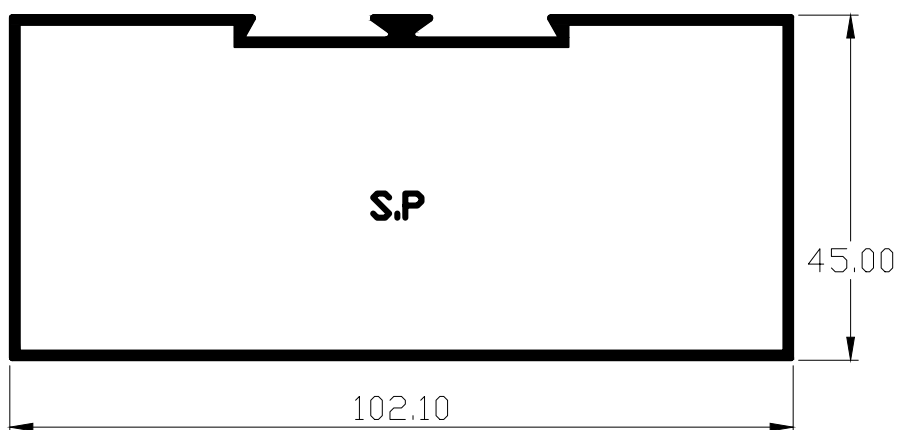

SECTION. NO	WT.Kgs/15' ft
14042	4.800 TO 5.100
14043	5.800 TO 6.100
14044	6.800 TO 7.100
14045	10.700 TO 11.00

# PARAGON ALUMINIUM L.L.P

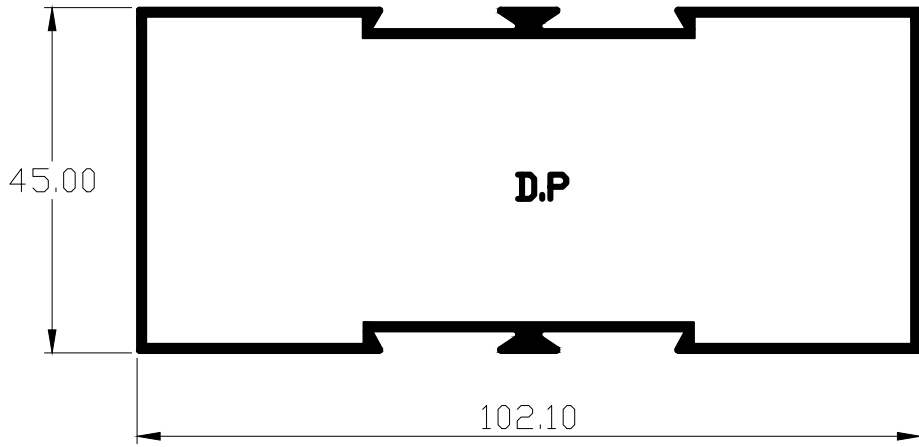

SECTION. NO	WT.Kgs/15' ft
14050	4.800 TO 5.100
14051	5.800 TO 6.100
14052	6.800 TO 7.100
14053	10.700 TO 11.100
14079	9.400 TO 9.700

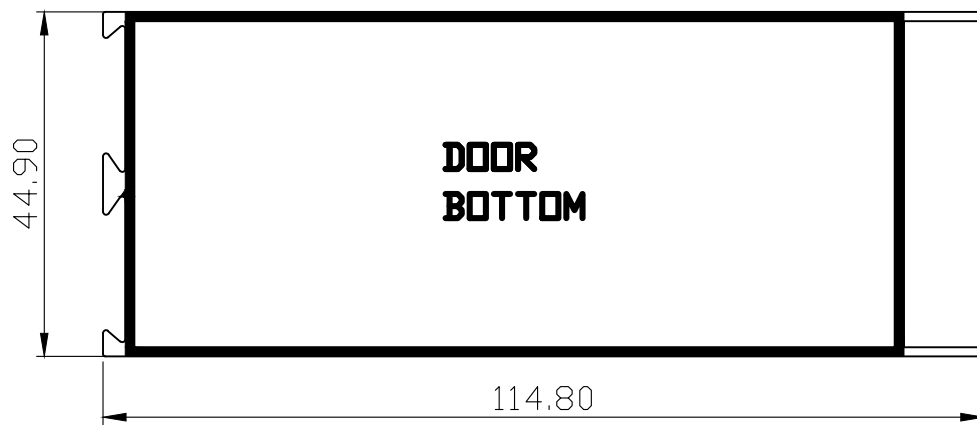

SECTION. NO	WT.Kgs/15' ft
14055	5.00 TO 5.300
14058	6.800 TO 7.100
14059	10.700 TO 11.00

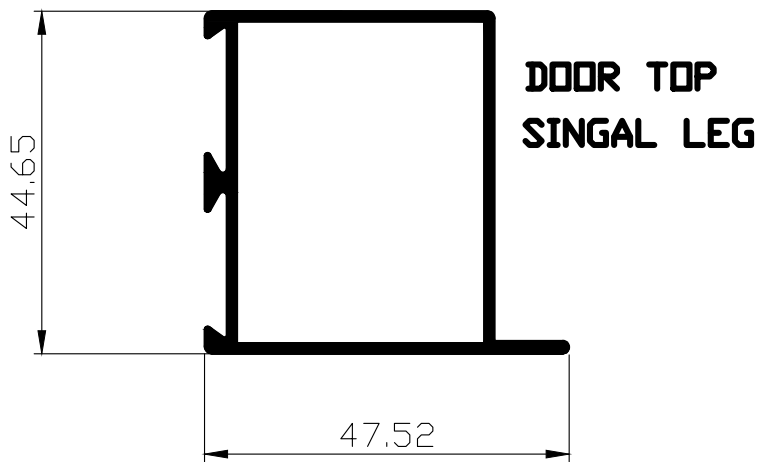

SECTION. NO	WT.Kgs/15' ft
15006	2.800 TO 3.100
15007	3.800 TO 4.100
15008	4.800 TO 5.100
15009	6.800 TO 7.100

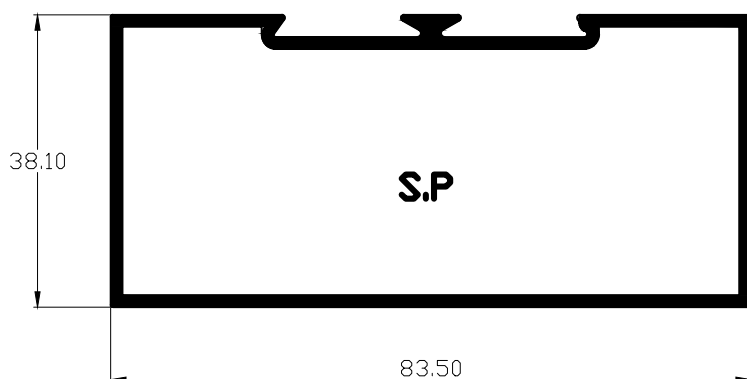

SECTION. NO	WT.Kgs/15' ft
14076	4.800 TO 5.100
14077	6.800 TO 7.100

# PARAGON ALUMINIUM L.L.P

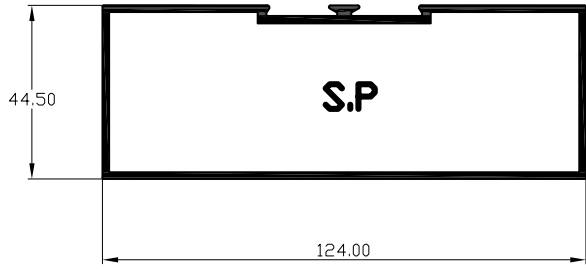

SECTION. NO	WT.Kgs/15' ft
28060	8.00 TO 8.300

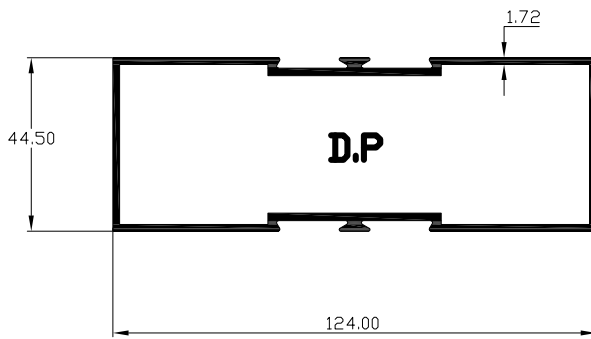

SECTION. NO	WT.Kgs/15' ft
28061	8.00 TO 8.300

SECTION. NO	WT.Kgs/15' ft
14074	3.800 TO 4.100

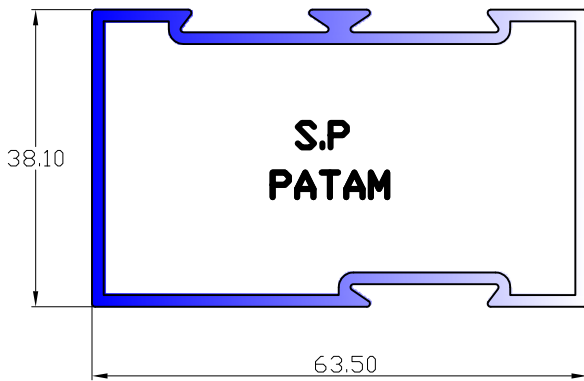

SECTION. NO	WT.Kgs/15' ft
26032	1.200 TO 1.400

**PATAM  
CLIP**

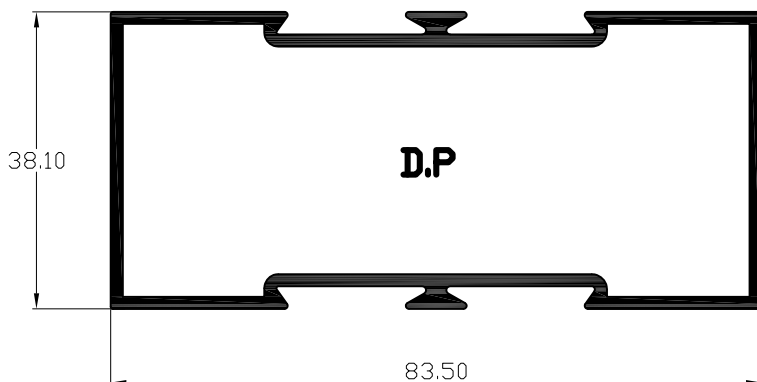
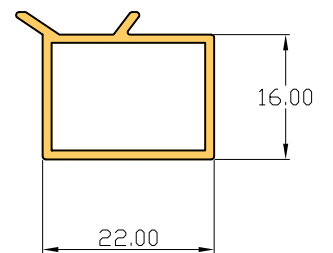

SECTION. NO	WT.Kgs/15' ft
14075	4.800 TO 5.100
14078	6.800 TO 7.100

# PARAGON ALUMINIUM L.L.P

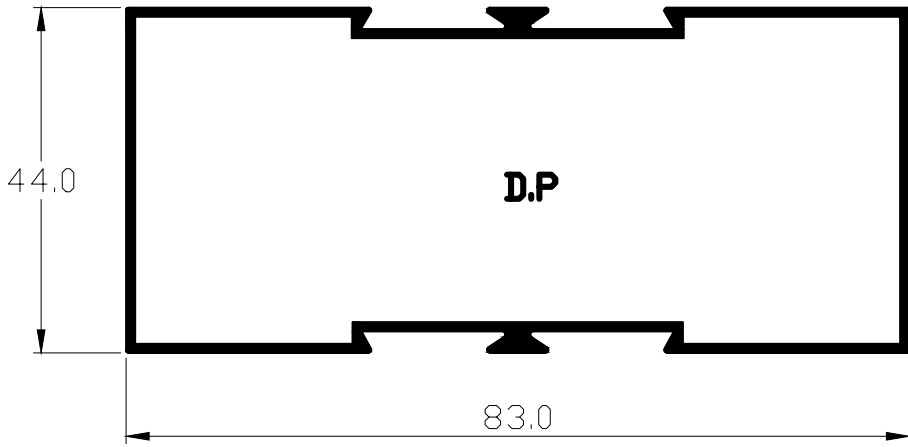

SECTION. NO	WT.Kgs/15' ft
14080	4.800 TO 5.100

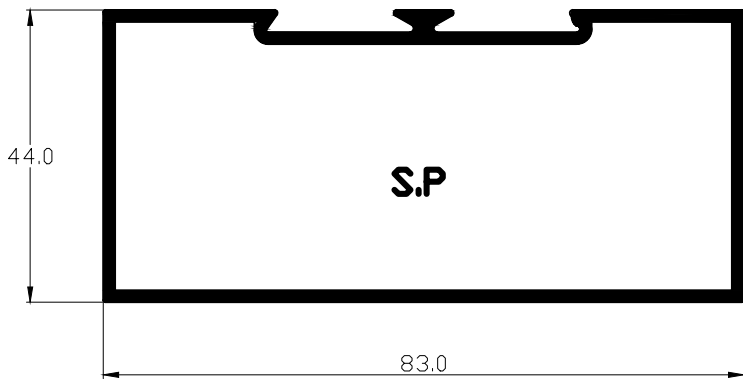

SECTION. NO	WT.Kgs/15' ft
14081	4.800 TO 5.100

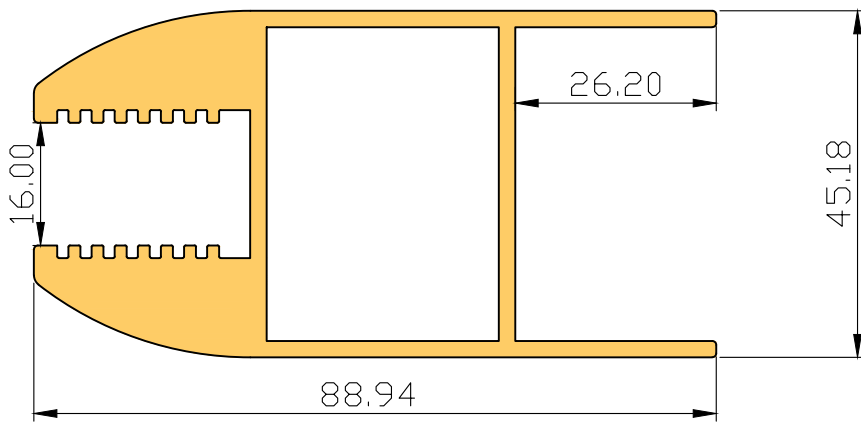

SECTION. NO	WT.Kgs/15' ft
1699	12.800 TO 13.100

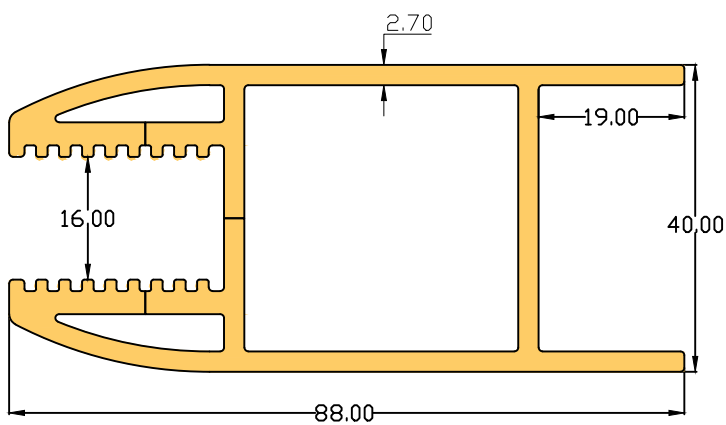

SECTION. NO	WT.Kgs/15' ft
26027	10.500 TO 11.0



# PARAGON ALUMINIUM L.L.P

SECTION. NO	WT.Kgs/15'ft
28071	13.700 TO 14.0

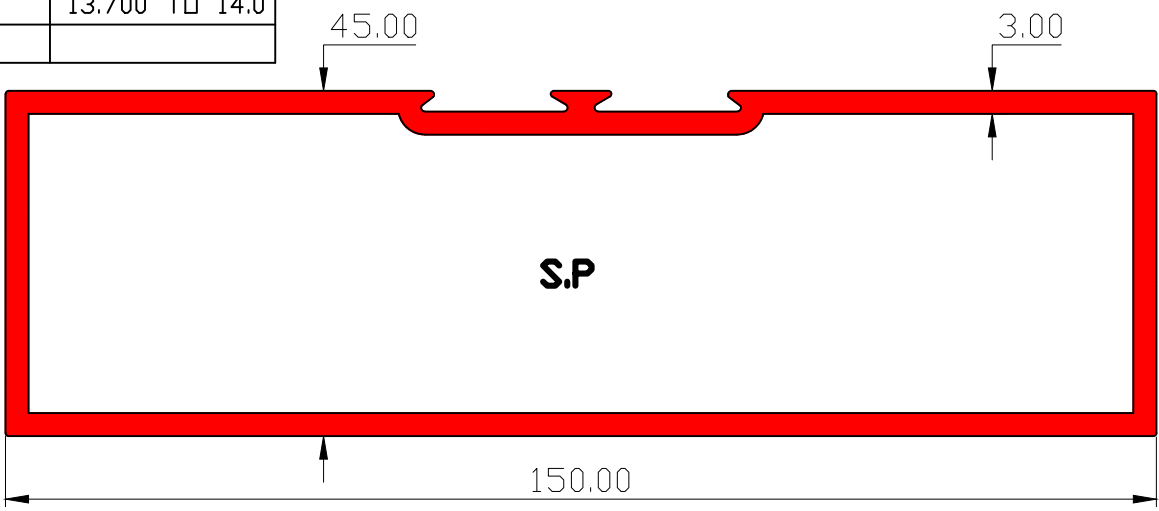

SECTION. NO	WT.Kgs/15'ft
28072	13.700 TO 14.0

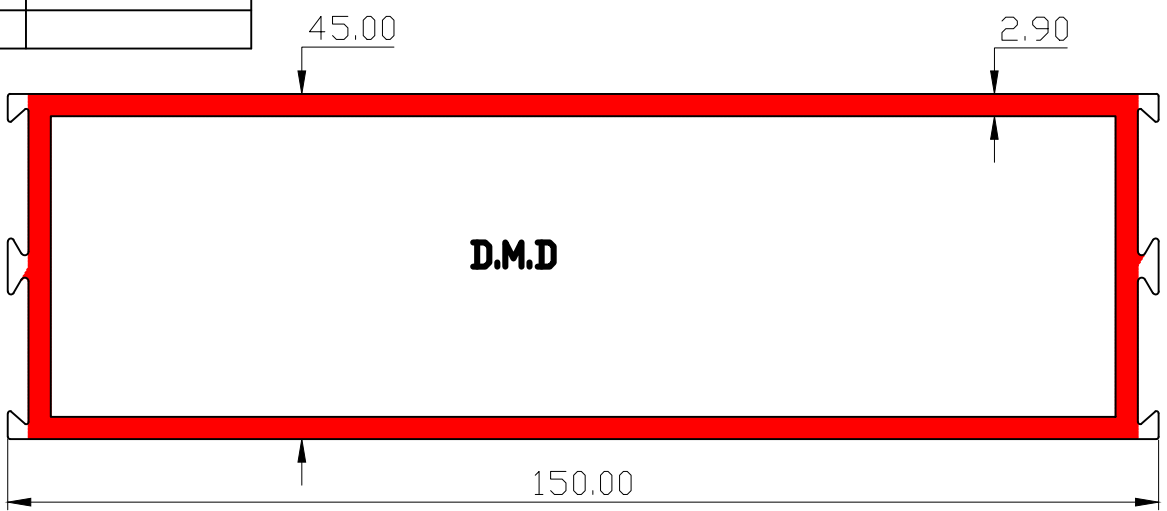

SECTION. NO	WT.Kgs/15'ft
28073	10.500 TO 10.800

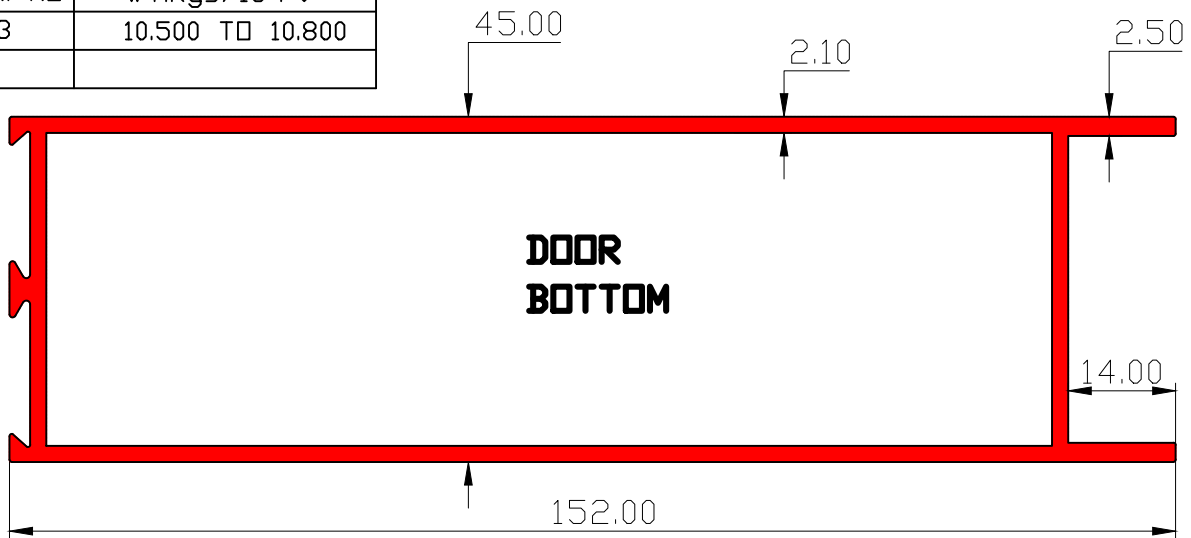

SECTION. NO	WT.Kgs/15'ft
30086	12.300 TO 12.600

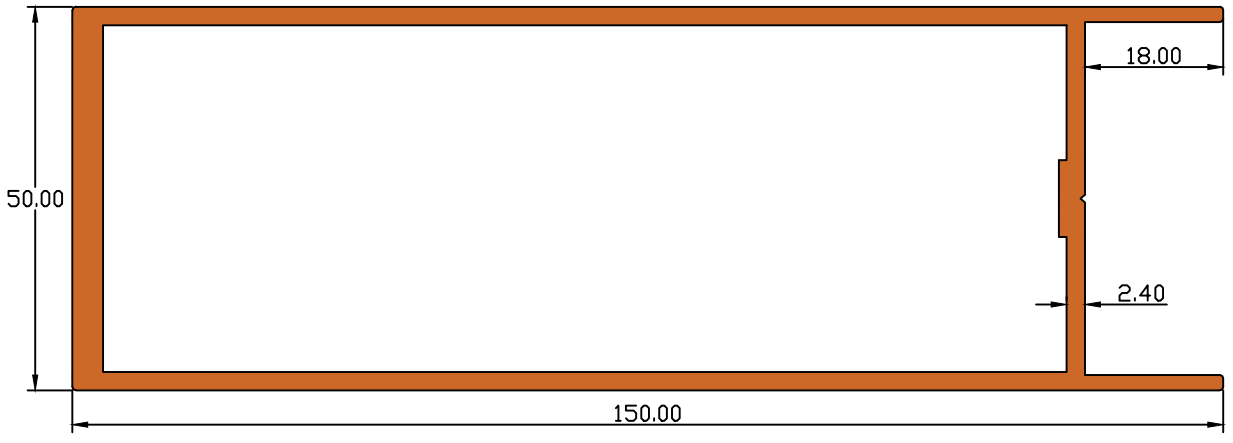

# PARAGON ALUMINIUM L.L.P

SECTION. NO	WT.Kgs/15'ft
30144	13.700 TO 14.0

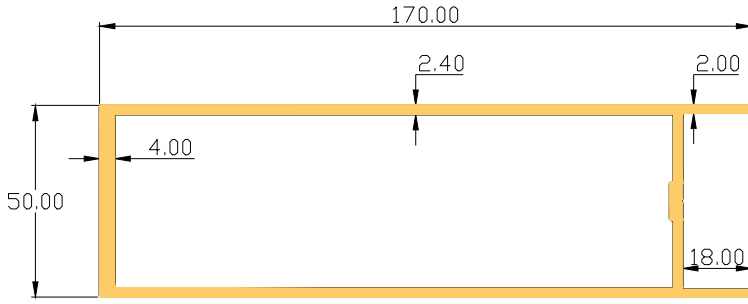

SECTION. NO	WT.Kgs/15'ft
30145	5.300 TO 5.600

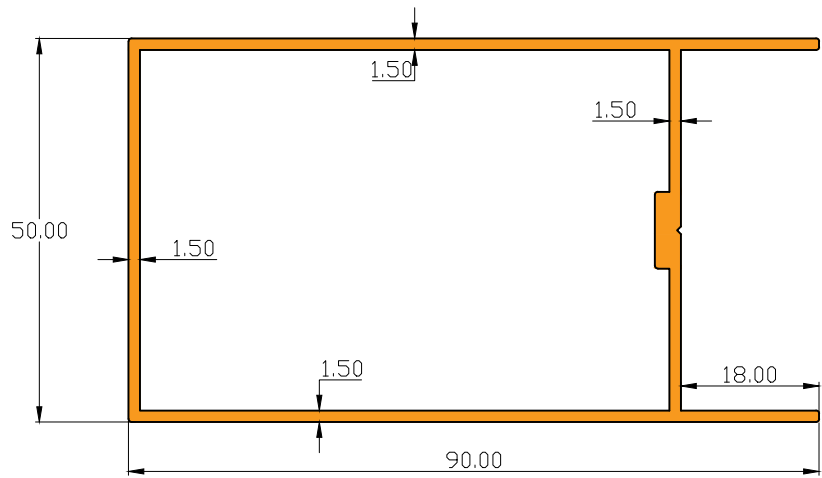

SECTION. NO	WT.Kgs/15'ft
30087	5.500 TO 5.800

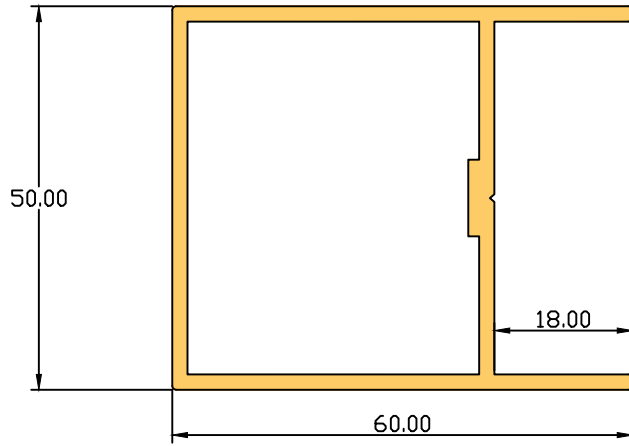

SECTION. NO	WT.Kgs/15'ft
30182	9.100 TO 9.400

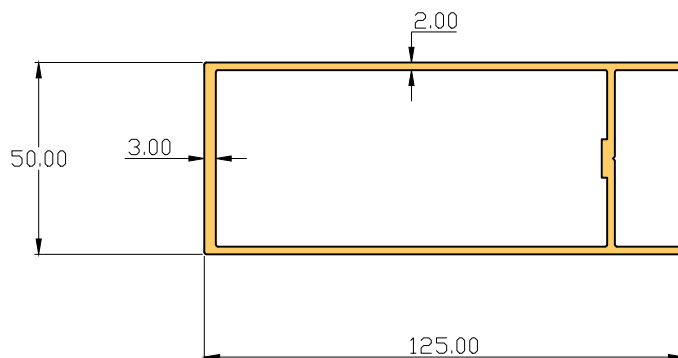

# PARAGON ALUMINIUM L.L.P

SECTION. NO	WT.Kgs/15'ft
30006	3.600 TO 3.800

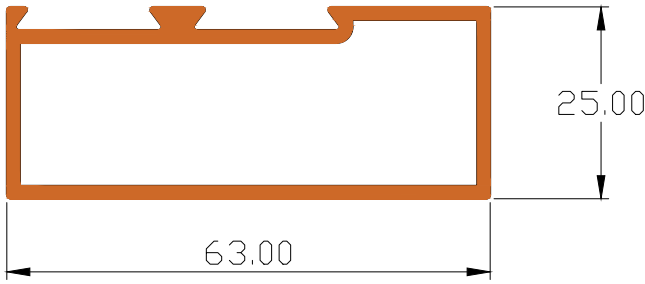

SECTION. NO	WT.Kgs/15'ft
30007	3.600 TO 3.800

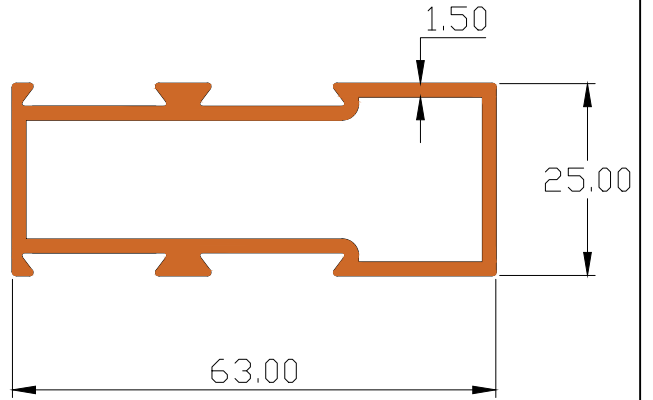

SECTION. NO	WT.Kgs/15'ft
30008	1.800 TO 2.00

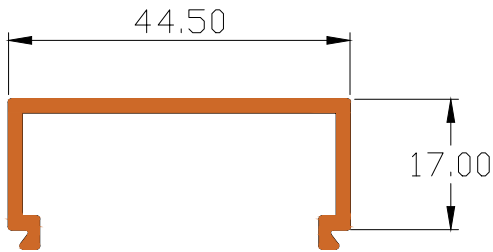

SECTION. NO	WT.Kgs/15'ft
28007	3.700 to 4.00

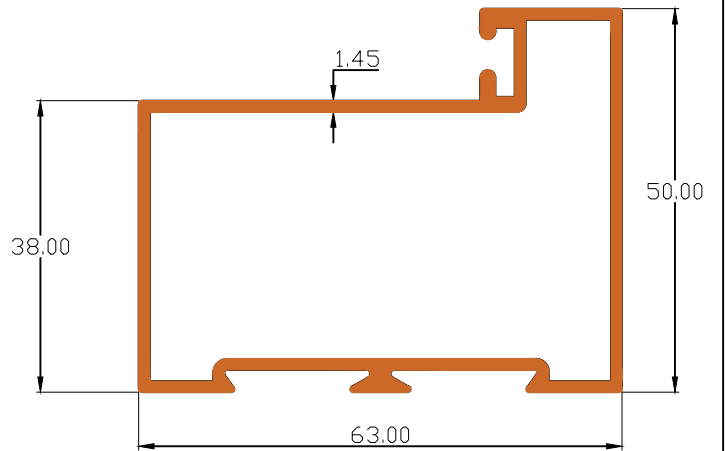

SECTION. NO	WT.Kgs/15'ft
28008	4.700 to 5.00

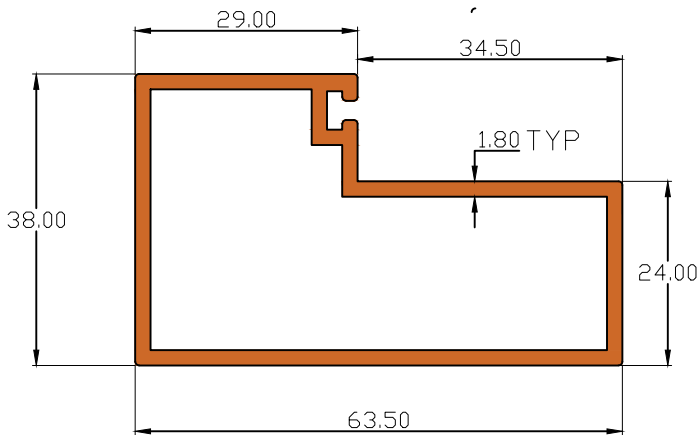

SECTION. NO	WT.Kgs/15'ft
28010	6.700 to 8.00 10.800 to 11.100

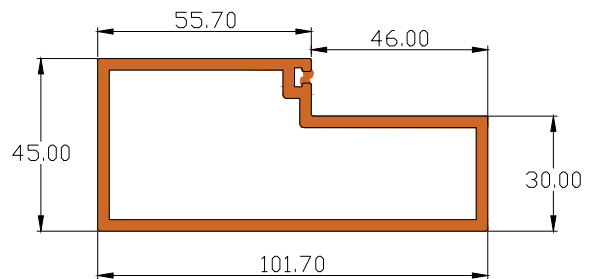

SECTION. NO	WT.Kgs/15'ft
1341	6.700 to 8.00 10.800 to 11.100

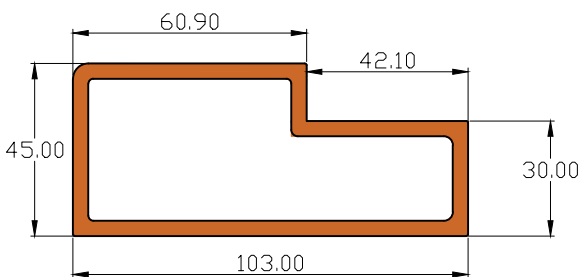

SECTION. NO	WT.Kgs/15'ft
30190	4.200 to 4.400

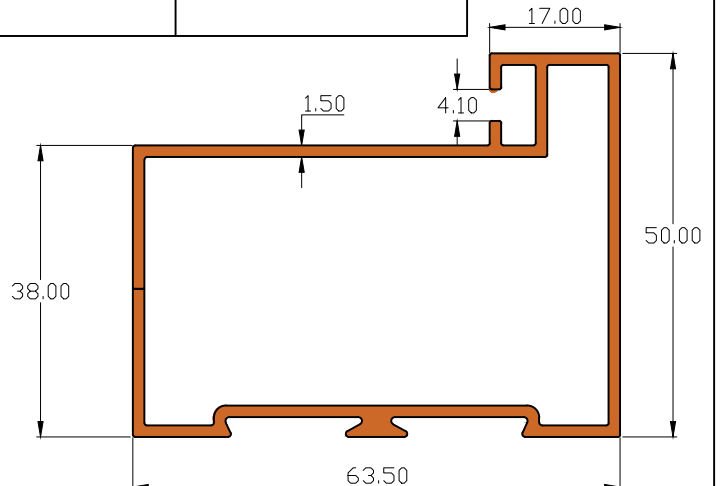

# PARAGON ALUMINIUM L.L.P

SECTION. NO	WT.Kgs/Mtr
1777	1.500

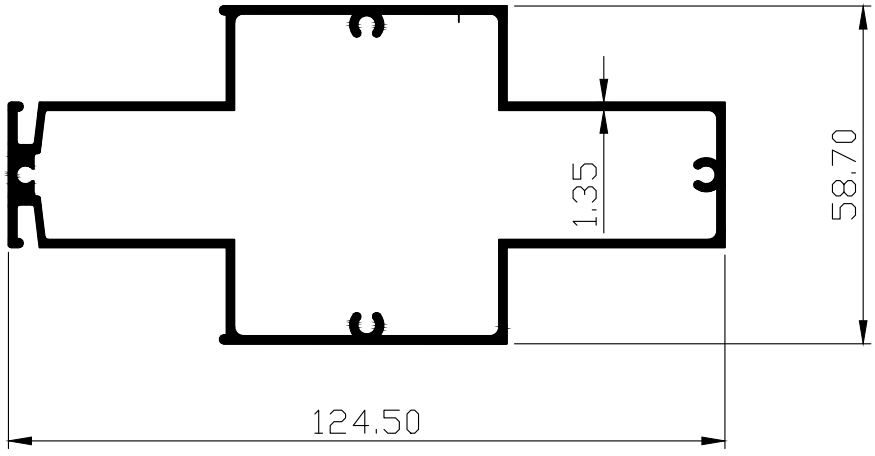

SECTION. NO	WT.Kgs/Mtr
1776	1.080

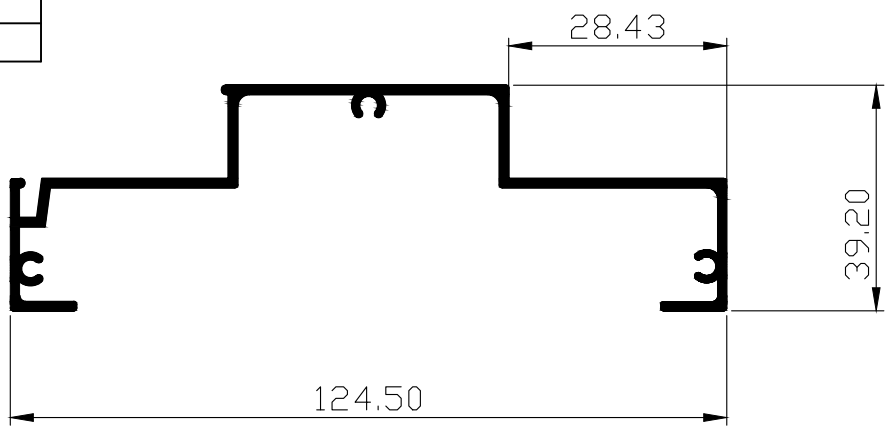

SECTION. NO	WT.Kgs/Mtr
30317	3.499

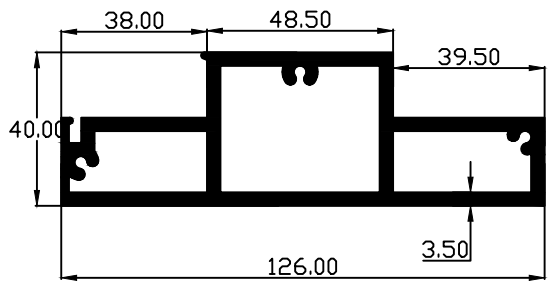

SECTION. NO	WT.Kgs/Mtr
30319	1.220

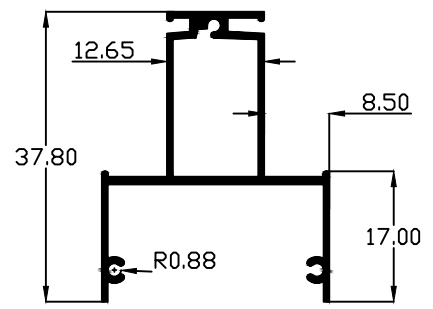

SECTION. NO	WT.Kgs/Mtr
30312	3.238

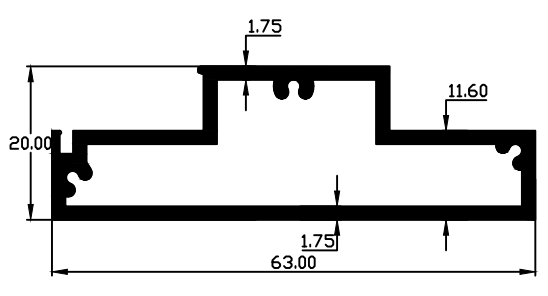

SECTION. NO	WT.Kgs/Mtr
30318	3.952

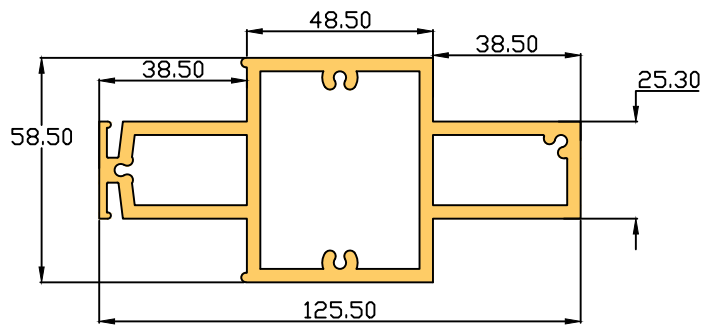

# PARAGON ALUMINIUM L.L.P

SECTION. NO	WT.Kgs/Mtr
28031	0.917

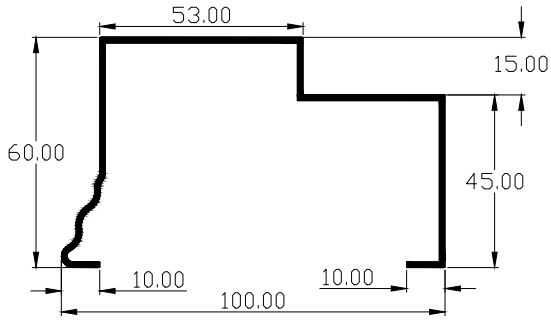

SECTION. NO	WT.Kgs/Mtr
28032	1.080

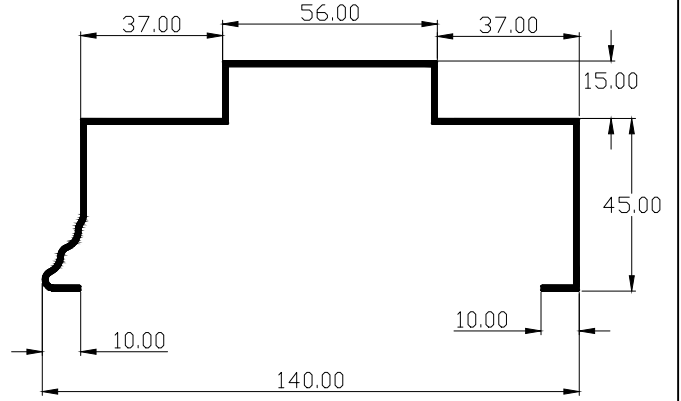

SECTION. NO	WT.Kgs/Mtr
28033	0.608
P-16	

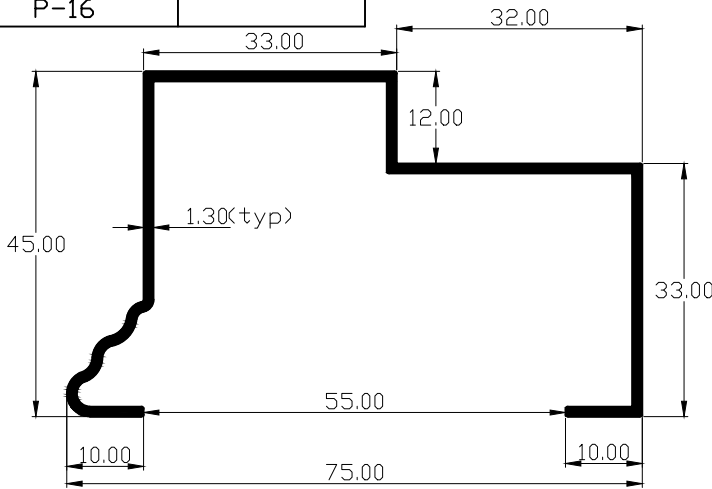

SECTION. NO	WT.Kgs/Mtr
28034	1.315

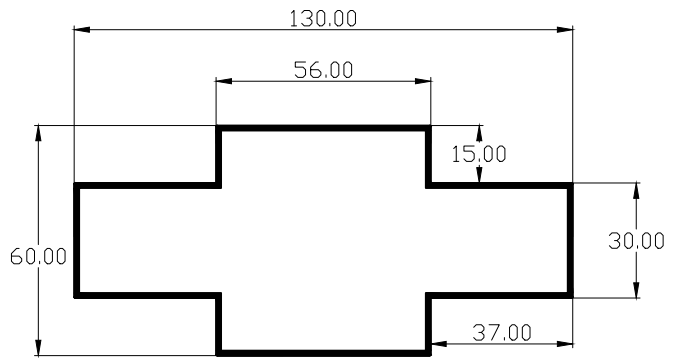

SECTION. NO	WT.Kgs/Mtr
28035	0.753
P-16	

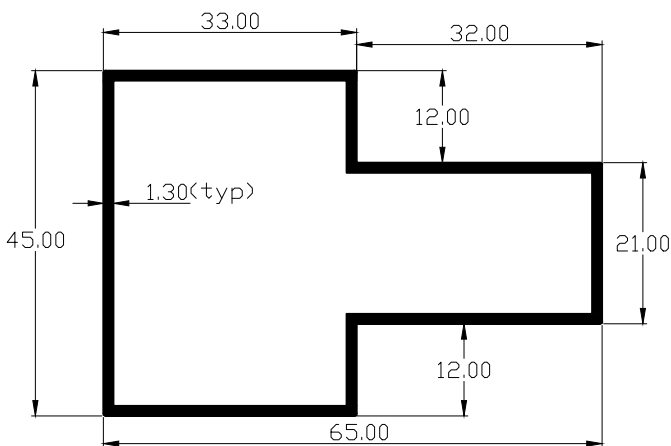

SECTION. NO	WT.Kgs/Mtr
28030	1.190
P-16	

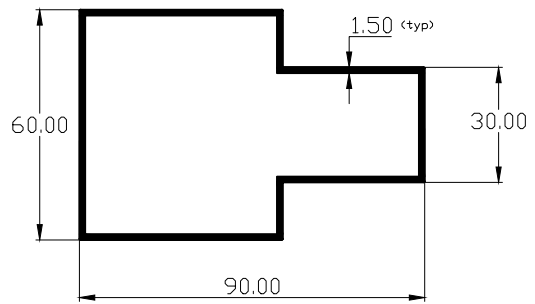

SECTION. NO	WT.Kgs/Mtr
1456	2.101

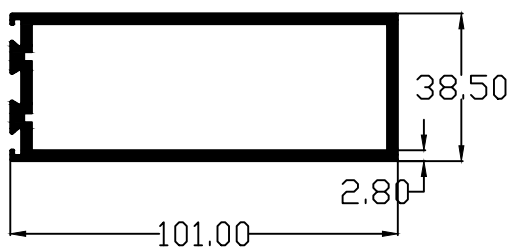

SECTION. NO	WT.Kgs/Mtr
26012	0.971

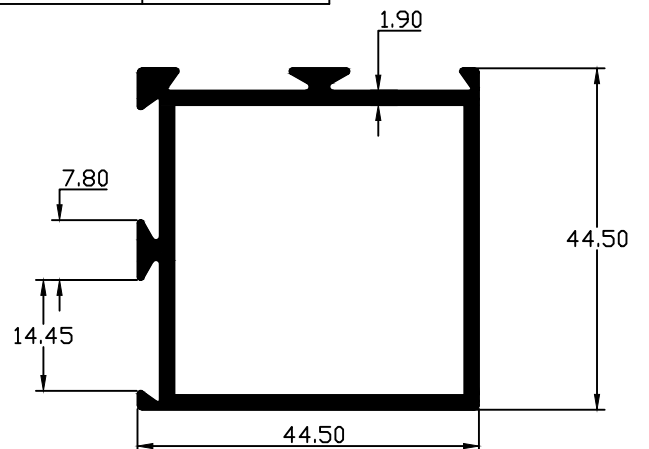

# PARAGON ALUMINIUM L.L.P

SECTION. NO	WT.Kgs/Mtr
1790	0.572

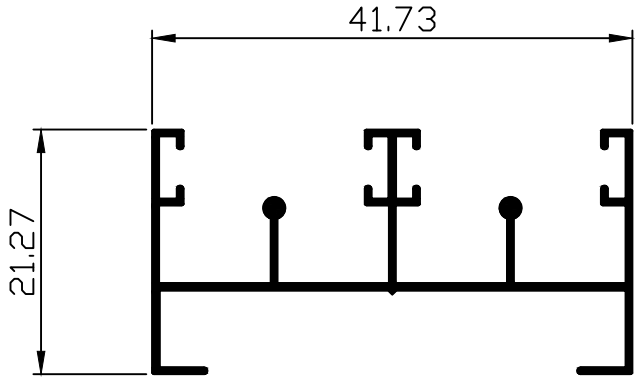

SECTION. NO	WT.Kgs/Mtr
1787	0.734

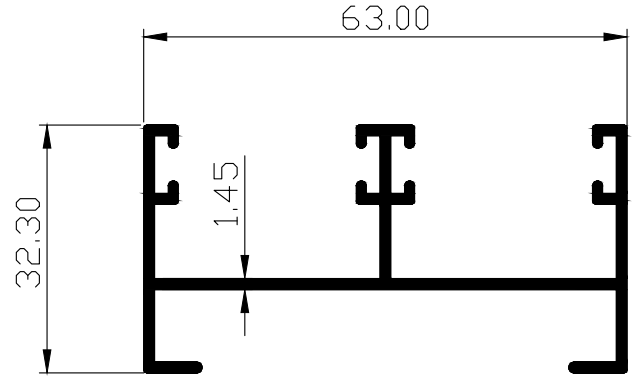

SECTION. NO	WT.Kgs/Mtr
30043	0.585

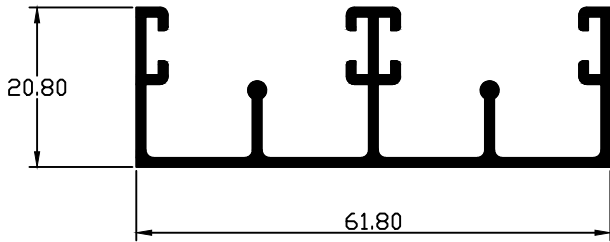

SECTION. NO	WT.Kgs/Mtr
30044	0.509

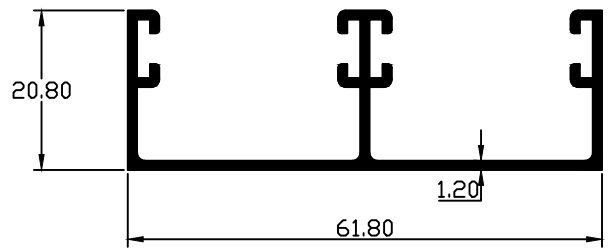

SECTION. NO	WT.Kgs/Mtr
26023	0.466

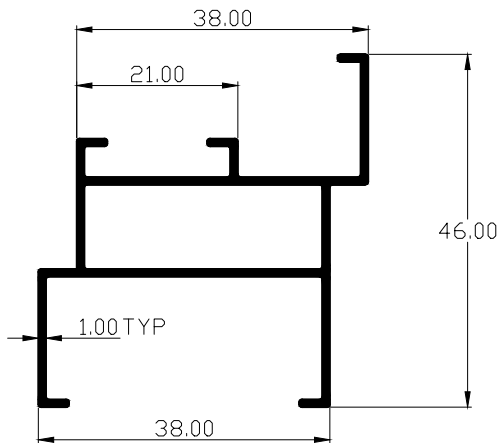

SECTION. NO	WT.Kgs/Mtr
26034	0.308

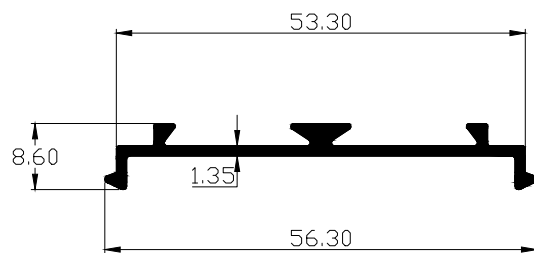

SECTION. NO	WT.Kgs/Mtr
26021	1.088

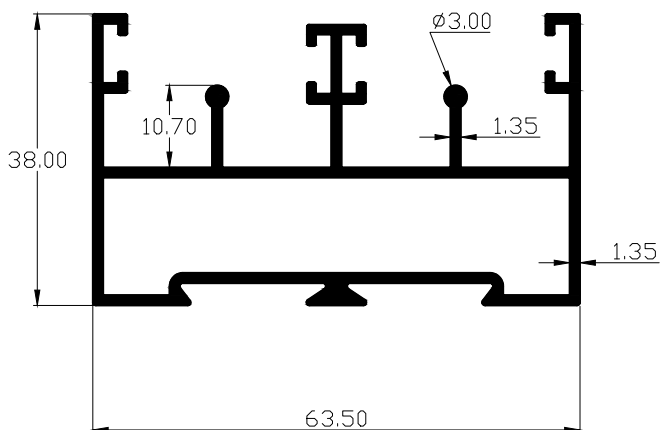

SECTION. NO	WT.Kgs/Mtr
26022	1.00

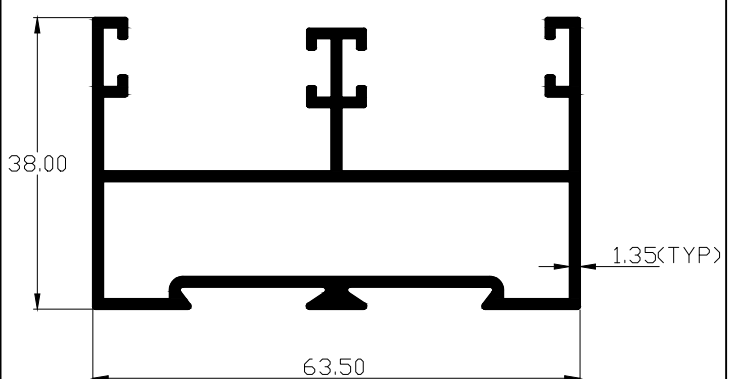

# PARAGON ALUMINIUM L.L.P

SECTION. NO	WT.Kgs/Mtr
30186	0.776

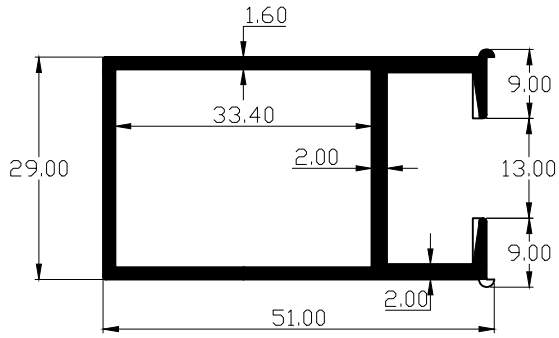

SECTION. NO	WT.Kgs/Mtr
30187	0.911

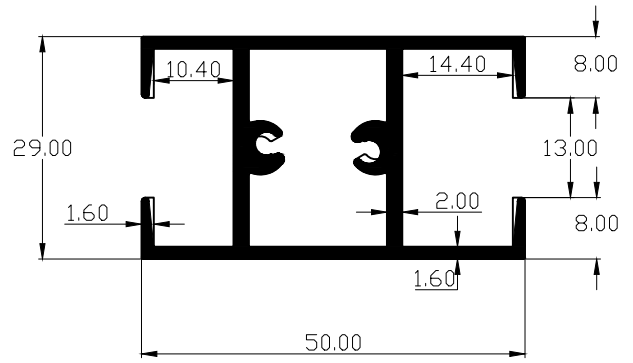

SECTION. NO	WT.Kgs/Mtr
30188	0.878

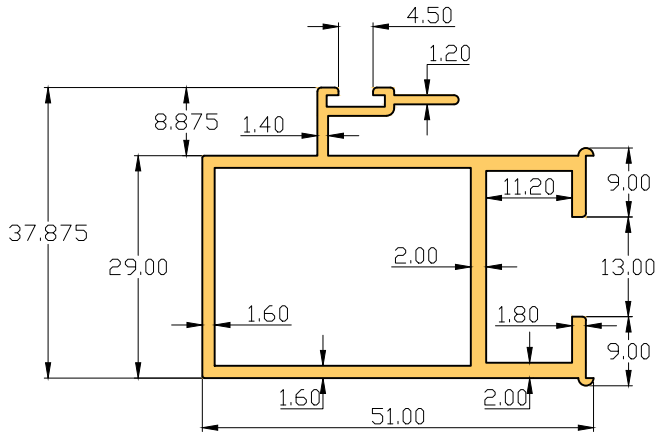

SECTION. NO	WT.Kgs/Mtr
30189	0.999

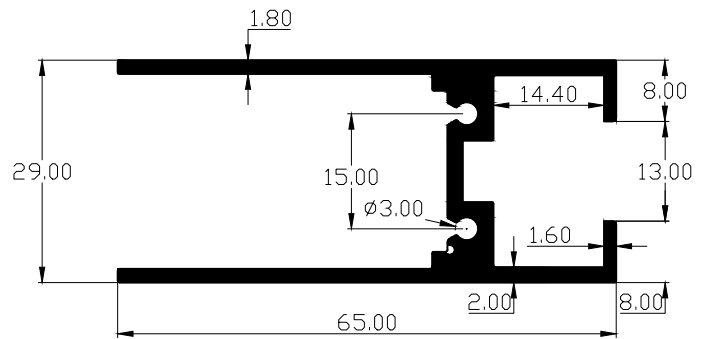

SECTION. NO	WT.Kgs/Mtr
7014	0.746

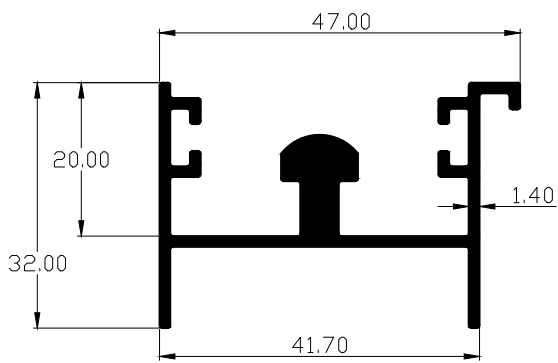

SECTION. NO	WT.Kgs/Mtr
7015	0.803
P-16	

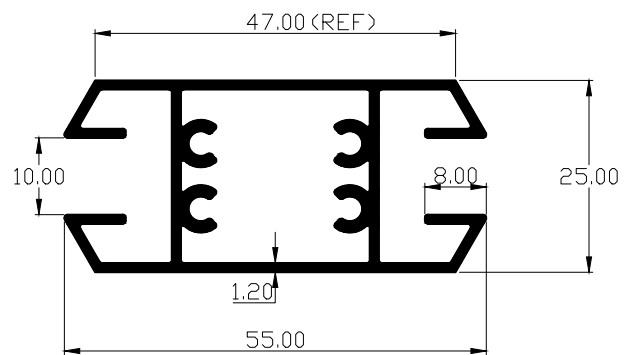

SECTION. NO	WT.Kgs/Mtr
30184	1.177

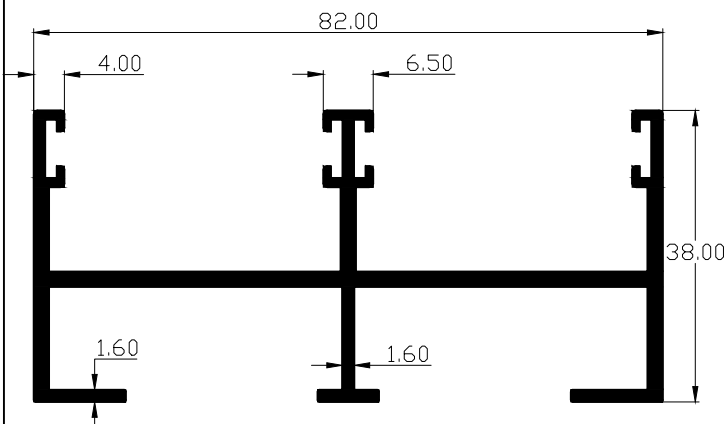

SECTION. NO	WT.Kgs/Mtr
30185	1.370

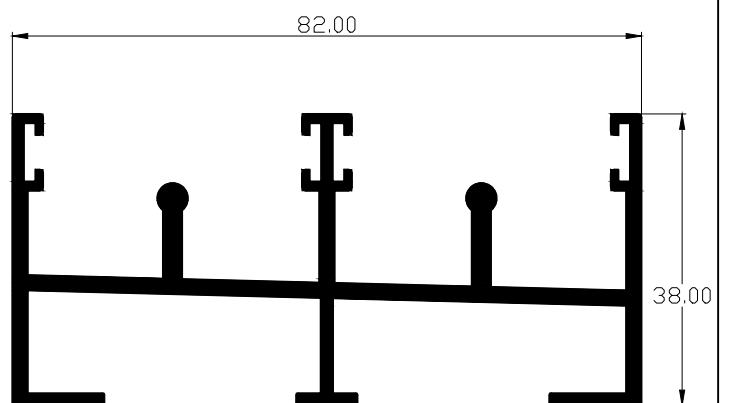

# PARAGON ALUMINIUM L.L.P

SECTION. NO	WT.Kgs/Mtr
28049	0.682

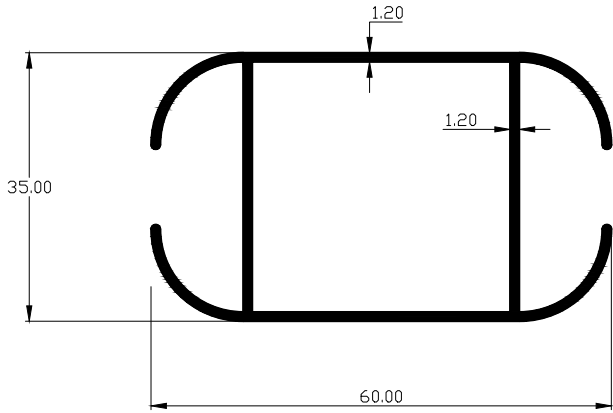

SECTION. NO	WT.Kgs/Mtr
28050	0.748

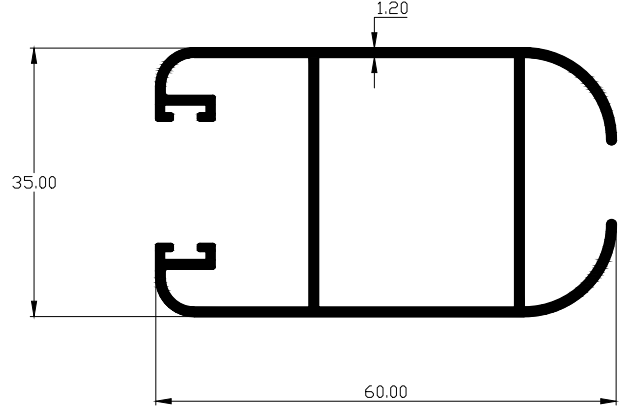

SECTION. NO	WT.Kgs/Mtr
28051	0.353
P-16	

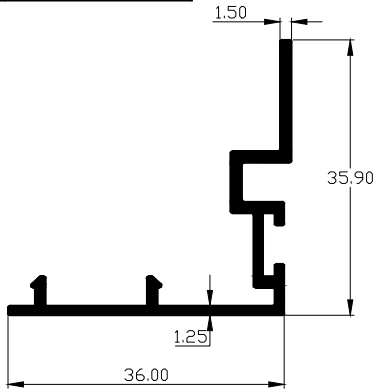

SECTION. NO	WT.Kgs/Mtr
28052	0.513
P-16	

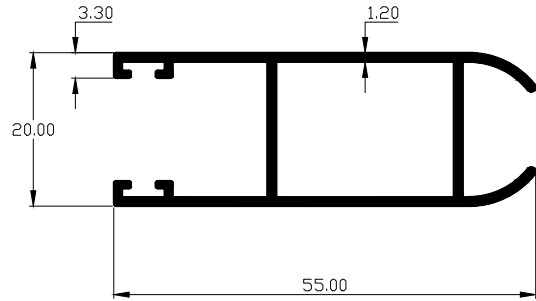

SECTION. NO	WT.Kgs/Mtr
28053	0.279
P-16	

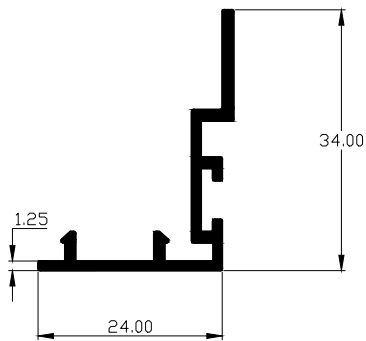

SECTION. NO	WT.Kgs/Mtr
28054	0.610
P-16	

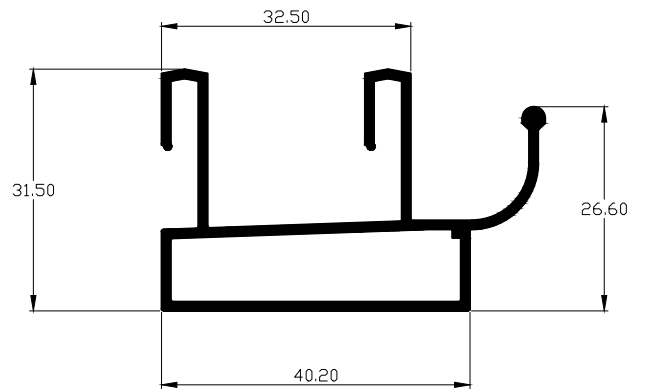

SECTION. NO	WT.Kgs/Mtr
28055	0.918
P-16	

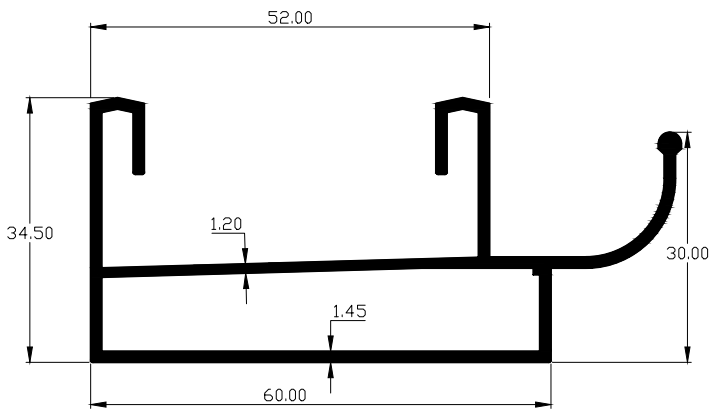

SECTION. NO	WT.Kgs/Mtr
7013	0.765

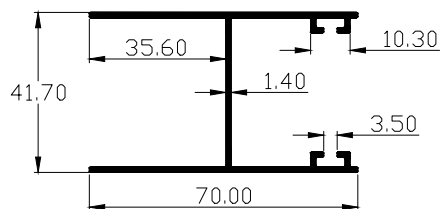



# PARAGON ALUMINIUM L.L.P

SECTION. NO	WT.Kgs/Mtr
26001	0.412

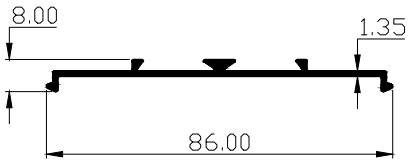

SECTION. NO	WT.Kgs/Mtr
26002	1.475

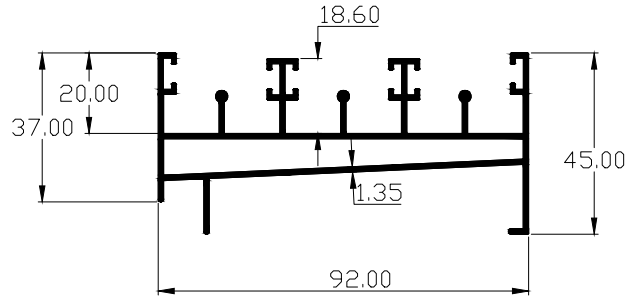

SECTION. NO	WT.Kgs/Mtr
26035	1.589

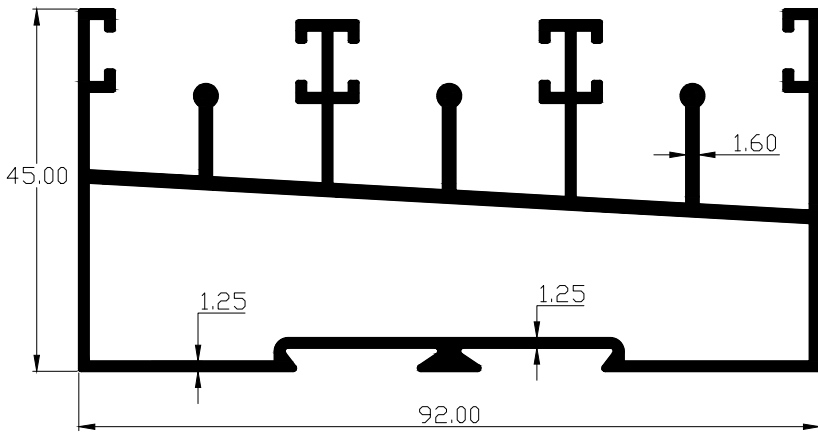

SECTION. NO	WT.Kgs/Mtr
26004	1.357

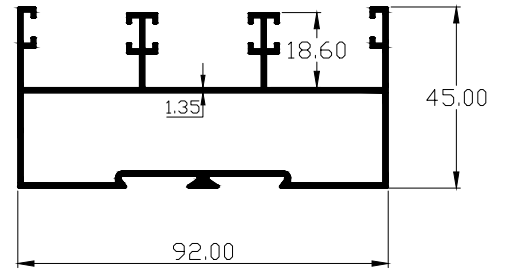

SECTION. NO	WT.Kgs/Mtr
1780	0.742

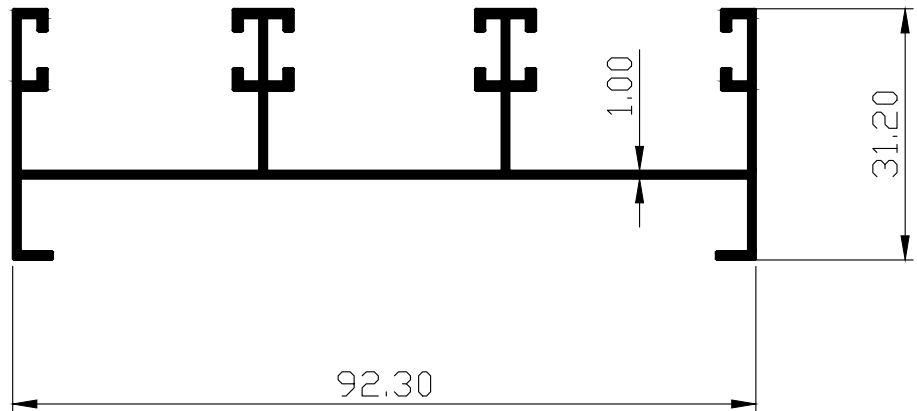

SECTION. NO	WT.Kgs/Mtr
1781	0.765

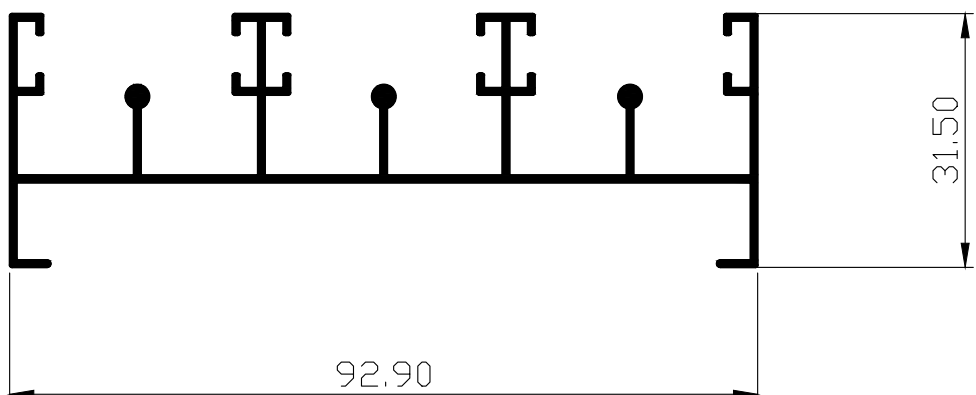

# PARAGON ALUMINIUM L.L.P

SECTION. NO	WT.Kgs/Mtr
28043	0.568

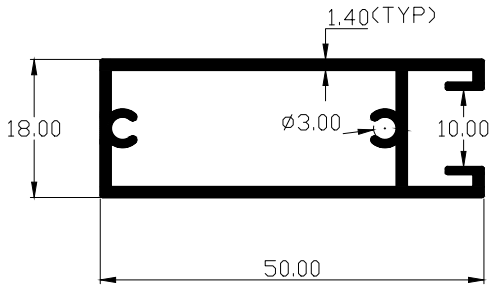

SECTION. NO	WT.Kgs/Mtr
28044	0.568

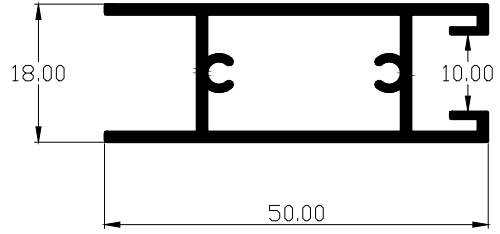

SECTION. NO	WT.Kgs/Mtr
28045	0.700

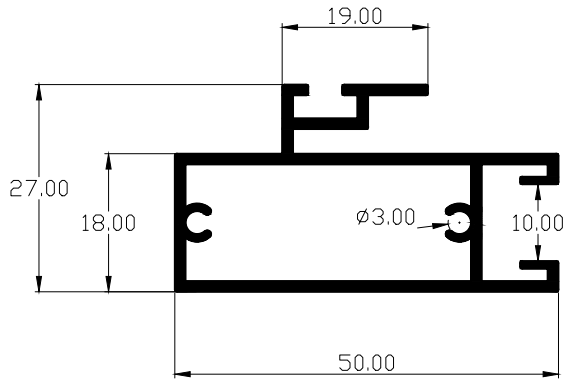

# PARAGON ALUMINIUM L.L.P

SECTION. NO	WT.Kgs/Mtr
26045	0.490

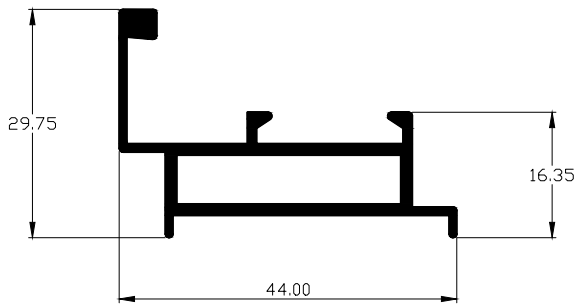

SECTION. NO	WT.Kgs/Mtr
26046	0.486

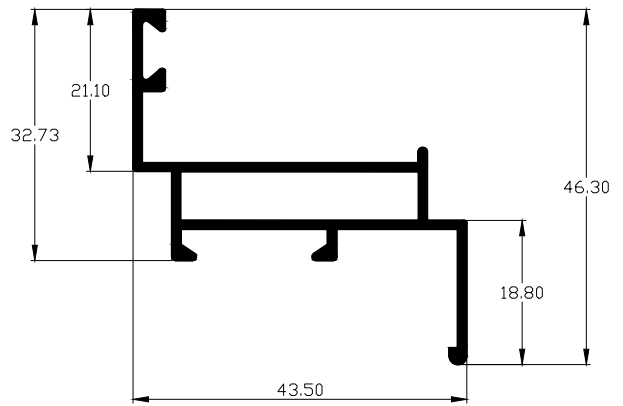

SECTION. NO	WT.Kgs/Mtr
1461	0.668

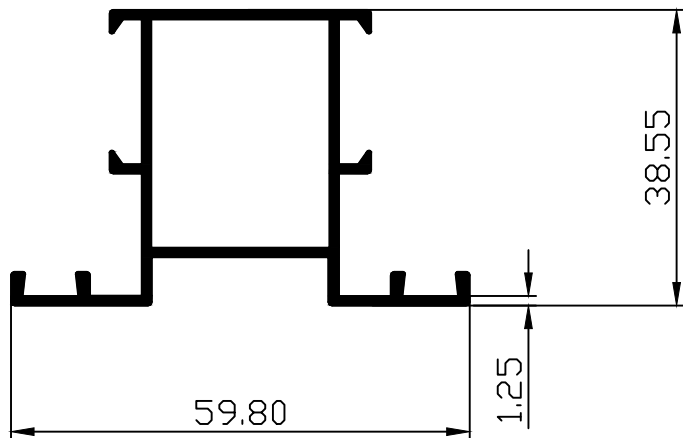

SECTION. NO	WT.Kgs/Mtr
1466	0.520

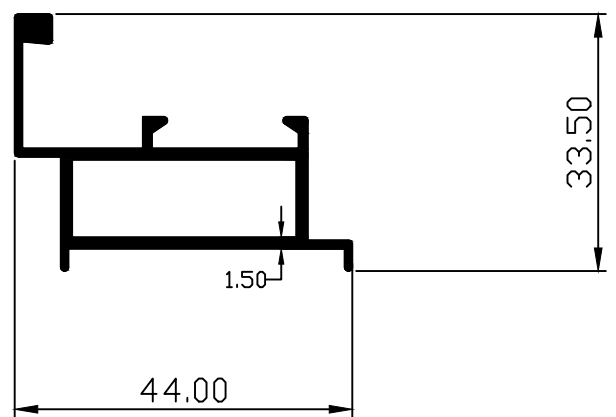

SECTION. NO	WT.Kgs/Mtr
1471	0.502

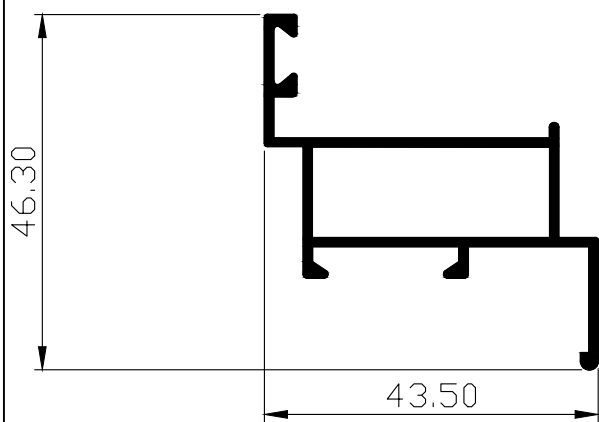

SECTION. NO	WT.Kgs/Mtr
24004	0.311
P-16	

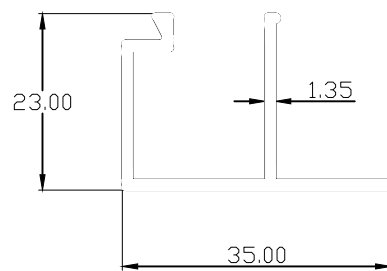

SECTION. NO	WT.Kgs/Mtr
24005	0.158

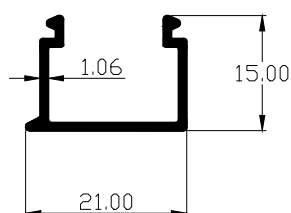

SECTION. NO	WT.Kgs/Mtr
26047	0.762
P-16	

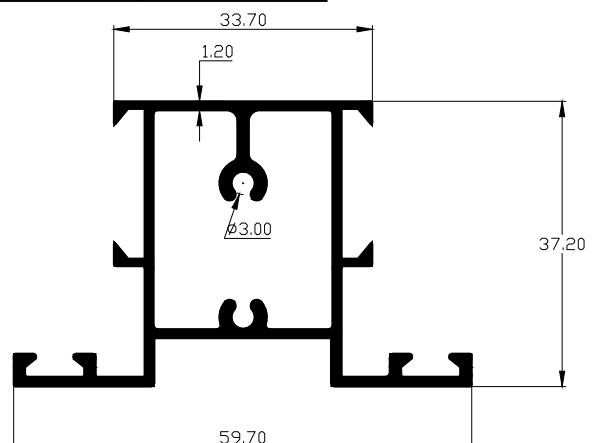

# PARAGON ALUMINIUM L.L.P

SECTION. NO	WT.Kgs/Mtr
26005	0.303

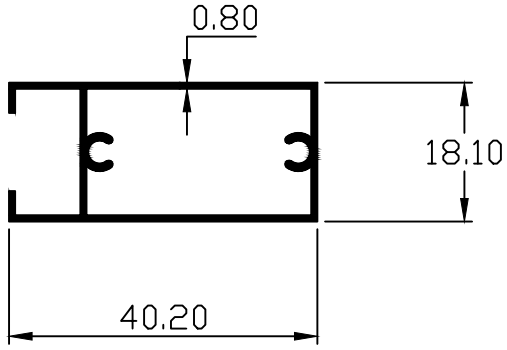

SECTION. NO	WT.Kgs/Mtr
26006	0.343

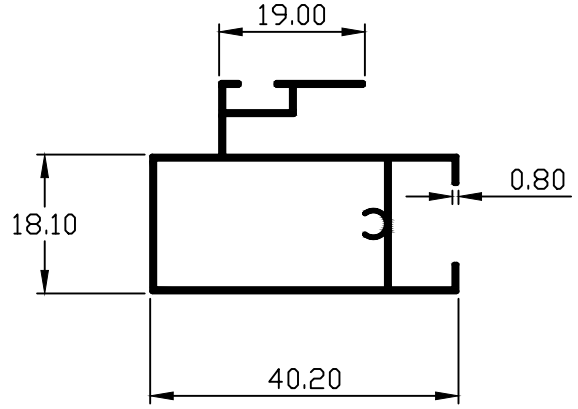

SECTION. NO	WT.Kgs/Mtr
26007	0.350

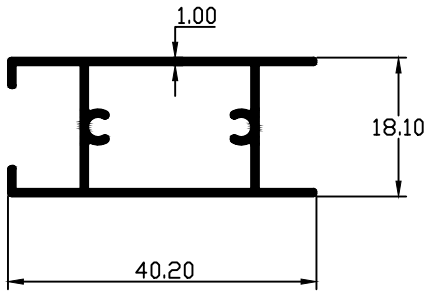

SECTION. NO	WT.Kgs/Mtr
26020	0.405

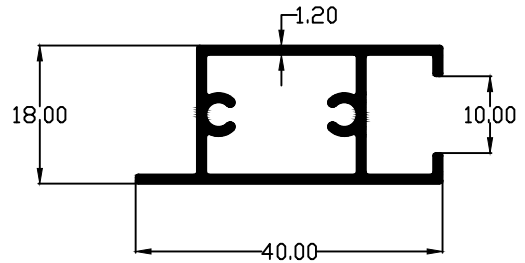

SECTION. NO	WT.Kgs/Mtr
30041	0.508

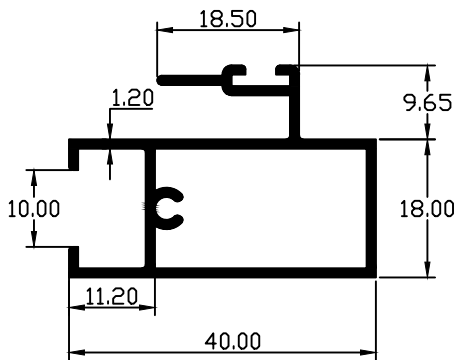

SECTION. NO	WT.Kgs/Mtr
30042	0.403

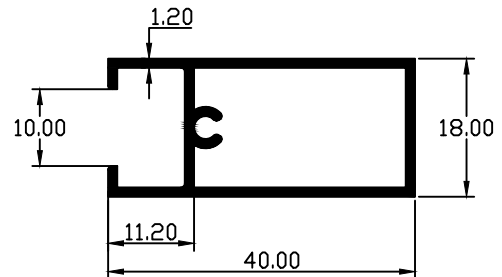

SECTION. NO	WT.Kgs/Mtr
30039	0.512

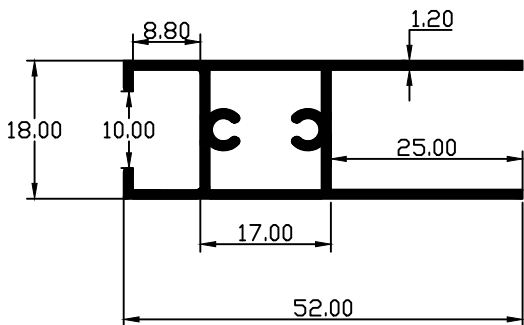

SECTION. NO	WT.Kgs/Mtr
30040	0.434

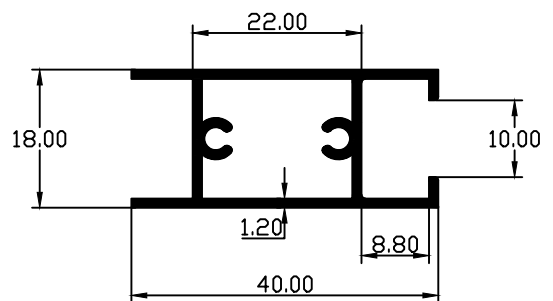

# PARAGON ALUMINIUM L.L.P

SECTION. NO	WT.Kgs/Mtr
28074	1.100

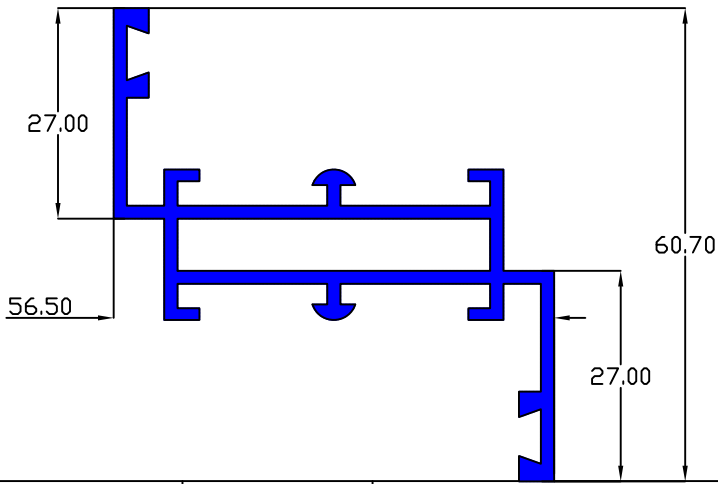

SECTION. NO	WT.Kgs/Mtr
30082	0.797

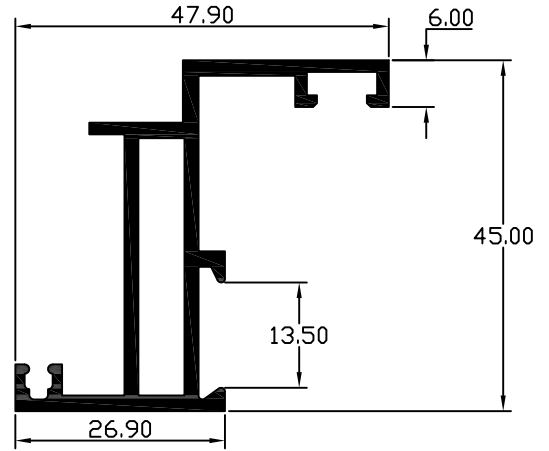

SECTION. NO	WT.Kgs/Mtr
30037	0.654

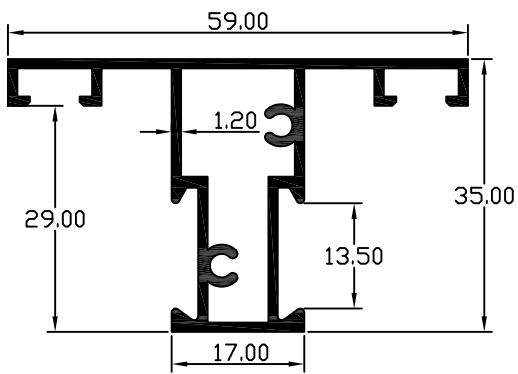

SECTION. NO	WT.Kgs/Mtr
30038	0.385

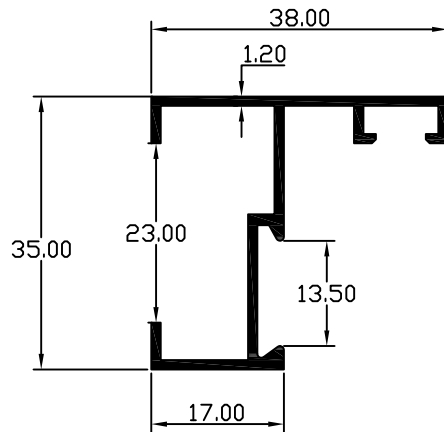

SECTION. NO	WT.Kgs/Mtr
30045	0.287

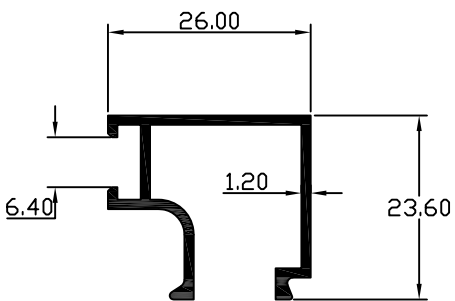

SECTION. NO	WT.Kgs/Mtr
30046	0.240

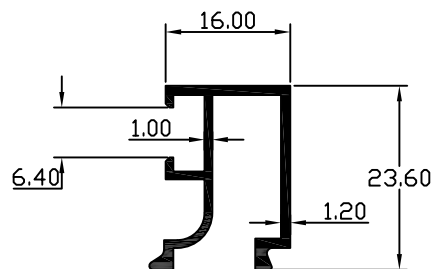

SECTION. NO	WT.Kgs/Mtr
30047	0.112

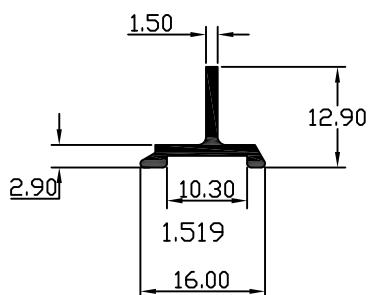

SECTION. NO	WT.Kgs/Mtr
30048	0.510

